



**SF8025-T**

**SF8075-T**

**SF8150-T**

Laser Diode Driver with TEC Controller  
for Butterfly LD Type 2 Telecom



**Table of content**

- 1. Laser diode driver features ..... 3
- 2. Applications ..... 3
- 3. TEC controller features..... 3
- 4. Controls ..... 3
- 5. Description ..... 3
- 6. Package set ..... 3
- 7. Versions ..... 4
- 8. Absolute maximum ratings..... 4
- 9. Recommended operating conditions ..... 4
- 10. Power supply requirements ..... 5
- 11. Electrical characteristics..... 5
- 12. Typical Performance Characteristics ..... 6
- 13. Pin and terminal functions..... 7
- 14. Analogue control description ..... 10
- 15. Current / Temperature setting variants..... 12
- 16. How to get started ..... 12
- 17. Cooling ..... 12
- 18. Internal protections ..... 13
- 19. Software ..... 13
- 20. Digital control description ..... 13
- 21. Digital control description (extended) ..... 17
- 22. Mechanical dimensions..... 20



## 1. Laser diode driver features

- Constant current mode
- Low current ripple  $\leq 10\mu\text{A}$
- Current stability 0.1%
- No need to adjust voltage
- Soft-start
- Adjustable current limit
- Reverse current protection
- Crowbar circuit protection
- Own software

## 2. Applications

- Supplying laser diodes in butterfly case

## 5. Description

SF8xxx contains a laser diode driver and a temperature controller (TEC).

Laser diode driver is a non-isolated low drop out (LDO) regulator with constant current output. Driver produces high stability and low ripple current.

TEC is a non-isolated DC/DC. TEC produces low current ripples. Additional features include an adjustable TEC output current limit and Integrated self-adjusted PID controller, providing optimal temperature regulation.

SF8xxx can be controlled by analogue signals.

SF8xxx is housed in  $61 \times 101.6$  mm package with aluminum base plate to aid thermal dissipation from laser diode. The laser diode mount is located on the board. Driver can be mounted on any thermal conductive surface enough to dissipate laser diode losses.

## 6. Package set

- Driver – 1 pcs
- 50 cm ribbon cable with one 8-pin connector – 1 pcs
- 50 cm ribbon cable with one 20-pin connector – 1 pcs
- USB-UART converter – 1 pcs
- Datasheet & User Manual – 1 pcs

## 3. TEC controller features

- Low current ripple  $\leq 2\text{mA}$
- Integrated PID controller, doesn't require setup
- Adjustable TEC output current limit
- Working with sensor NTC 10kOhm
- Additional NTC thermistor input

## 4. Controls

- Potentiometers on the board
- External input
- Digital control by RS-232/UART/USB<sup>1</sup>

---

<sup>1</sup> Option, USB as external adapter



## 7. Versions

Device	LDD MAX current, mA	LD mount	LD case
SF8025-10T	250	Soldering	10-pin Type 2
SF8025-ZIF10T	250	Plug-in connector	10-pin Type 2
SF8025-14T	250	Soldering	14-pin Type 2
SF8025-ZIF14T	250	Plug-in connector	14-pin Type 2
SF8075-10T	750	Soldering	10-pin Type 2
SF8075-ZIF10T	750	Plug-in connector	10-pin Type 2
SF8075-14T	750	Soldering	14-pin Type 2
SF8075-ZIF14T	750	Plug-in connector	14-pin Type 2
SF8150-10T	1500	Soldering	10-pin Type 2
SF8150-ZIF10T	1500	Plug-in connector	10-pin Type 2
SF8150-14T	1500	Soldering	14-pin Type 2
SF8150-ZIF14T	1500	Plug-in connector	14-pin Type 2

## 8. Absolute maximum ratings

	MIN	MAX	UNIT
V <sub>in+</sub> to V <sub>in-</sub>	-0.3	5.5	V
Operating temperature	-40	50	°C
Analogue control pins to GND	-0.3	5.5	V
RS-232 RXD to GND	-25	25	V
RS-232 TXD to GND	-13.2	13.2	V
UART RXD to GND	-0.3	5.5	V
UART TXD to GND	-0.3	5.5	V

Stresses beyond those listed under absolute maximum ratings may cause permanent damage to the device. These are stress ratings only, which do not imply functional operation of the device at these or any other conditions beyond those indicated under recommended operating conditions. Exposure to absolute-maximum-rated conditions for extended periods may affect device reliability.

## 9. Recommended operating conditions

	MIN	MAX	UNIT
Input voltage (V <sub>in</sub> )	4.8	5.2	V
Operating temperature	-10	40	°C
Analogue control pins to GND	0	5	V
RS-232 RXD to GND	-12	12	V
RS-232 TXD to GND	-12	12	V
UART RXD to GND	0	5	V
UART TXD to GND	0	5	V



## 10. Power supply requirements

The driver requires a 5V DC power supply. The power supply must be able to cover the driver and TEC output power and losses. The power supply must provide 25W or more.

## 11. Electrical characteristics

PARAMETER	TEST CONDITIONS	MIN	TYP	MAX	UNIT
<b>OUTPUT LDD</b>					
Output voltage		0.5		3	V
Output current	<b>SF8025</b>	0		250	Ma
	<b>SF8075</b>	0		750	
	<b>SF8150</b>	0		1500	
Current ripple			10	15	uA
Pulse rate	Set by RS-232 or UART	0.1		100	Hz
Pulse duration	Set by RS-232 or UART	1		5000	Ms
Rise time (Soft-start time)		2.5	4	5	Ms
Fall-time (Stop time)		0.7	1	1.5	Ms

<b>OUTPUT TEC</b>					
Output voltage		0		±4	V
Output current		0		±4	A
Current ripple			2	4	mA
Temperature change range		+15		+40	°C

<b>CONTROLS</b>					
Enable pins low threshold				1	V
Enable pins high threshold		2.3			V
Interlock pin threshold				1	V
Interlock pin pull-up resistance			10		kΩ
LDD current set pin voltage vs. output current	<b>SF8025</b>		100		mA/V
	<b>SF8075</b>		300		
	<b>SF8150</b>		600		
LDD current set step	Set by RS-232 or UART		0.5		mA
LDD current set accuracy			1		%
LDD current set calibration		-5		+5	%
TEC temperature set step	Set by RS-232 or UART		0.01		°C
TEC temperature set accuracy			1		%
TEC temperature set calibration		-5		+5	%

<b>AUX SUPPLY</b>					
2.5V accuracy			0.2		%
2.5V output current				10	mA

<b>INTERNAL MEASUREMENTS</b>					
Internal measurements accuracy			2		%
LDD current monitor pin voltage vs. output current	SF8025		100		mA/V
	SF8075		300		
	SF8150		600		
External sensor temperature	NTC 10k	-10		150	°C



INPUT					
Vin quiescent current		7	10	20	mA
Operating current				7	A

### 12. Typical Performance Characteristics

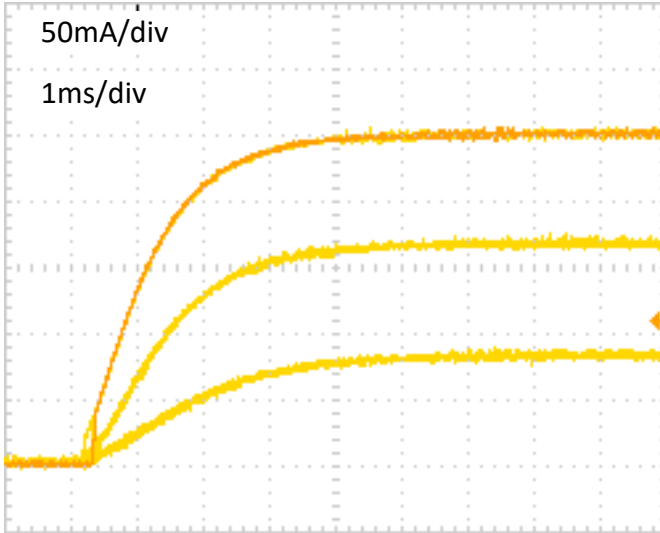

Fig. 1 – Typical start up sequence SF8025

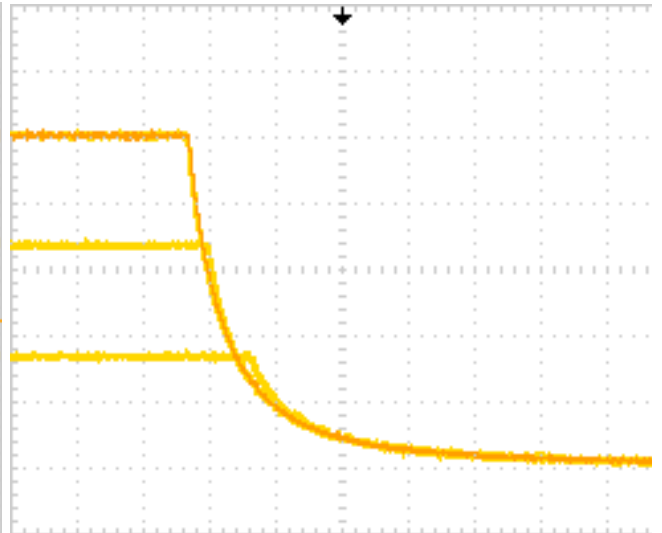

Fig. 2 – Typical stop sequence SF8025

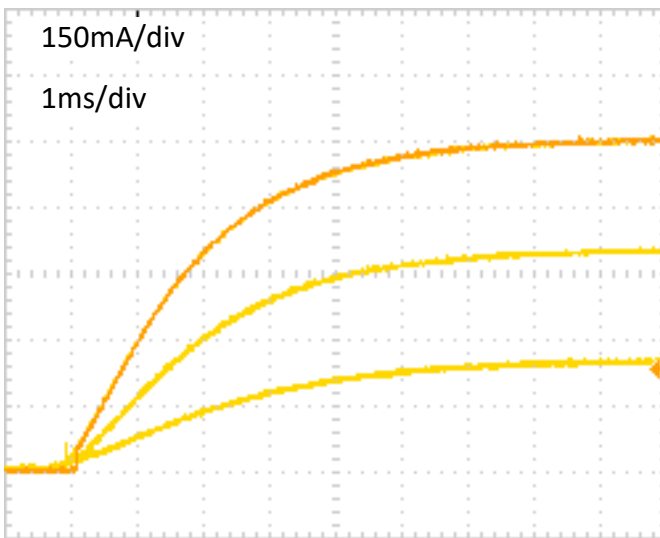

Fig. 3 – Typical start up sequence SF8075

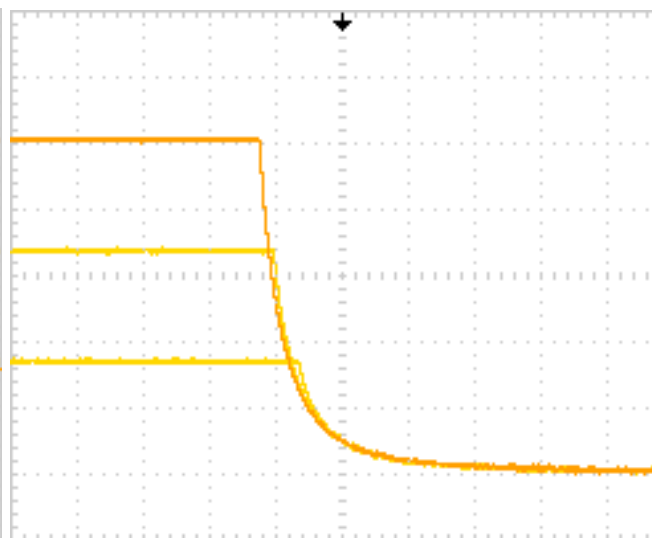

Fig. 4 – Typical stop sequence SF8075



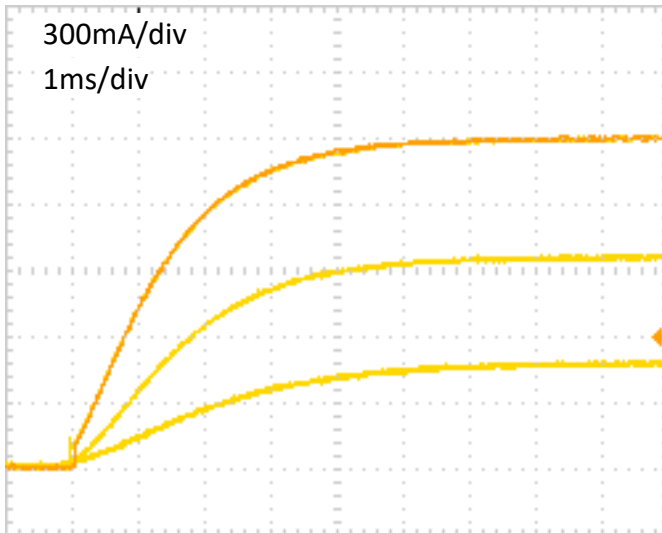

Fig. 5 – Typical start up sequence SF8150

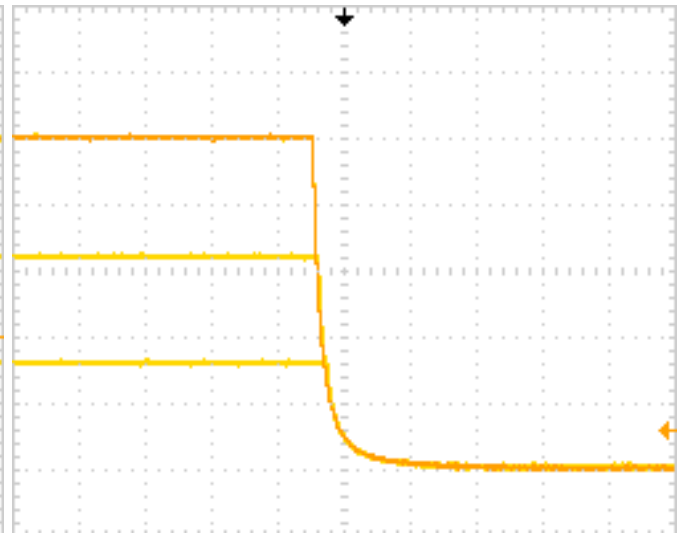

Fig. 6 – Typical stop sequence SF8150

### 13. Pin and terminal functions

**Please, note polarity!**

**Never ground any lead of the output, this may cause permanent damage to the laser diode and the driver!**

**Never use any grounded probes (e.g. from the oscilloscope) at the output!**

**Control pins are not isolated!**

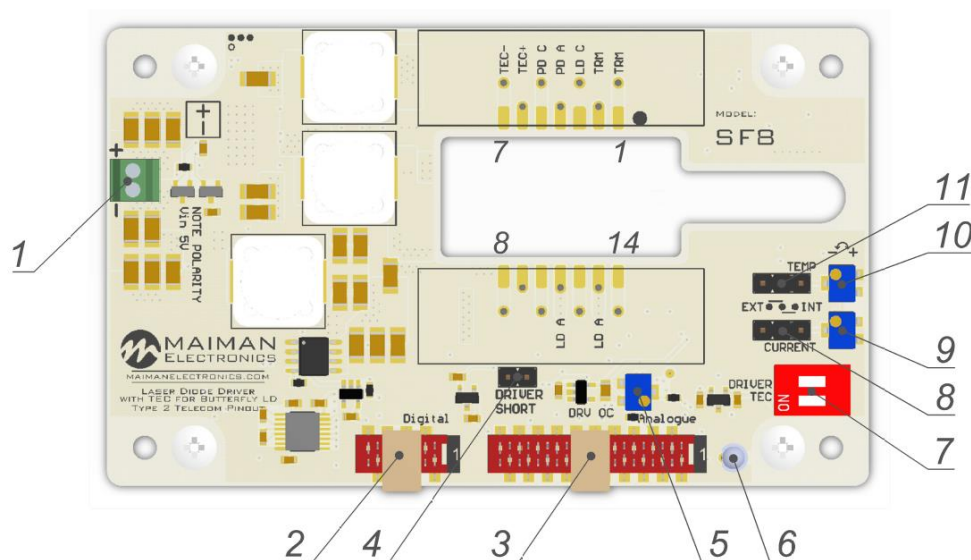

Fig. 7 – Controls

No	Description
1	Terminal for connecting the power supply 5V. Maximum wire cross-section 0.75 mm <sup>2</sup> . Please, note polarity!



2	Digital control connector
3	Analogue control connector
4	ESD protection LD short. Remove when the laser module is set up!
5	Current limit adjustment potentiometer. Turning the potentiometer clockwise increases the value, counterclockwise - reduces. Adjustment from zero to maximum occurs in 12 turns.
6	Laser diode driver overcurrent protection indicator. Lights red when the protection is activated. To reset, you must restart the device.
7	Two-position switch. One switch enables temperature controller (TEC), another switch enables laser diode driver (DRIVER). Switches are duplicated on the analog control connector.
8	Current control selector. Close 1-2 to use analog control connector (EXT), 2-3 to use potentiometer (INT).
9	Output current of laser diode driver adjustment potentiometer. Turning the potentiometer clockwise increases the value, counterclockwise - reduces. Adjustment from zero to maximum occurs in 12 turns.
10	TEC temperature adjustment potentiometer. Turning the potentiometer clockwise increases the value, counterclockwise - reduces. Adjustment from zero to maximum occurs in 12 turns.
11	The temperature control selector. Close 1-2 to use analog control connector (EXT), 2-3 to use potentiometer (INT).

**Digital control connector**

Würth WR-MM 690157000872 or TE Connectivity 215083-8

	Pin	Description
	1	UART RXD
	2	RS-232 RXD
	3	UART TXD
	4	RS-232 TXD
	5	Connected to Vin+
	6	Interlock (duplicates pin 15 of analogue control connector)
	7	Crowbar status (duplicates pin 5 of analogue control connector)
8	GND (connected to Vin- terminal)	

**Analogue control connector**

Würth WR-MM 6901 5700 20 72 or TE Connectivity 2-215083-0

PIN	I/O	Name	Description
1	O	+5V	Connected to Vin+.





2	I	TEC Enable	HIGH = operates, LOW = stop. Internally pulled down.
3	I	Laser Driver Enable	HIGH = operates, LOW = stop. Internally pulled down.
4	O	TEC Error	HIGH = fault, LOW = normal operation.
5	O	Laser Driver Overcurrent	HIGH = fault, LOW = normal operation.
6	O	+2.5V	Auxiliary +2.5V power supply. Up to 10mA output current capability.
7	I	Laser Current Set	0-2.5V = 0-MAX current at the output.
8		<b>GND</b>	
9	I	TEC temperature set	0V = 42°C, 2.5V = 16°C.
10		<b>GND</b>	
11	O	Driver Current Monitor	0-2.5V = 0-MAX current at the output.
12		<b>GND</b>	
13	O	TEC temperature monitor	0V = 42°C, 2.5V = 16°C.
14		<b>GND</b>	
15	I	Interlock	Open = locked; Low = operates. Internally pulled up.
16		<b>GND</b>	
17		NTC Interlock	Connect NTC thermistor 10k between this pin and GND.
18		<b>GND</b>	
19		Monitor PD Cathode	Connected to pin 5 of Butterfly.
20		Monitor PD Anode	Connected to pin 4 of Butterfly.

**Laser diode pinout**

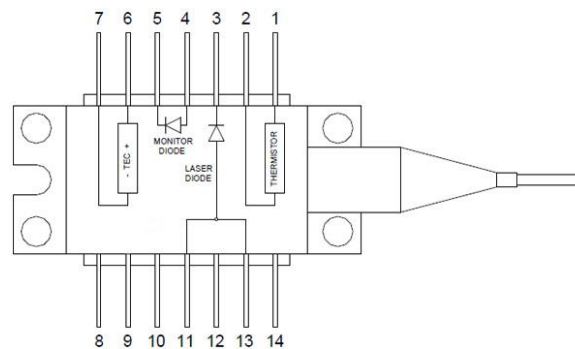

No	Description	No	Description
1	Thermistor	14	n/c
2	Thermistor	13	LD anode (+)
3	LD cathode (-)	12	n/c
4	PD anode (+)	11	LD anode (+)
5	PD cathode (-)	10	n/c
6	TEC anode (+)	9	n/c
7	TEC cathode (-)	8	n/c



## 14. Analogue control description

### 14.1. Laser Driver Enable / TEC Enable

The "Enable" contacts are logic inputs.

Apply high level to «*TEC Enable*» pin to start temperature stabilization. Apply low level to «*TEC Enable*» pin to stop temperature stabilization.

Apply high level to «*Laser Driver Enable*» pin to initiate soft-start sequence of laser diode driver. Apply low level to «*Laser Driver Enable*» pin to stop the driver.

The enable features are duplicated with on-off switches located on the board (7 in Fig. 7).

### 14.2. TEC Error

The «*TEC Error*» contact is logic output.

TEC error signal generates in overcurrent, short-circuit or circuitry overheat condition.

If an error occurs «*TEC Error*» pin becomes high.

A TEC error stops the laser driver. To reset the error, restart the device.

### 14.3. Laser Driver Overcurrent

The «*Laser Driver Overcurrent*» contact is logic output.

The «*Laser Driver Overcurrent*» pin is intended for monitoring the status of the protection circuits. When the current protection is activated, the laser driver stops, the output terminals are shunted, the LED on the board lights up red. The high logic level in the contact indicates the presence of shunting of the output terminals. The current generator cannot be restarted after the protection has tripped. To reset the protection, restart the driver.

### 14.4. Reference voltage 2.5V

The «*+2.5V*» pin is intended for supplying a reference voltage to external potentiometers etc., which may be used for current and temperature setting.

### 14.5. Laser Current Set

The «*Laser Current Set*» pin is an analog input.

The «*Laser Current Set*» is intended for setting the driver output current amplitude. Apply voltage to the «*Laser Current Set*» with respect to GND to control the output current. Signal resolution depends on driver model, maximum amplitude of the signal is 2.5V.

The «*Laser Current Set*» pin can be used for analogue modulation by applying sign, square or ramp signal with the DC component. Please, control the output current while using this feature. In this case, the value of the DC component determines the average current in the load, and the amplitude of the signal determines the modulation amplitude. It is necessary to ensure that the current for analog modulation does not exceed the current protection threshold. Analogue modulation amplitude depends on frequency.

**ATTENTION! If you use arbitrary/function generator or lab PS for current set, make sure it is in High Z mode, please, control the current set and current monitor pin voltages while getting started. When you are using a generator with an output "50 Ohms", the value on the screen of the device can be less**



than they actually set 2 times. Be careful, monitor the voltage on the contact «Laser Current Set» with an oscilloscope.

#### 14.6. TEC temperature set

The «TEC temperature set» pin is an analog input.

The «TEC temperature set» is intended for setting the desired temperature of laser module. Apply voltage to the «TEC temperature set» with respect to GND To set the desired temperature.

The applied voltage must correspond to the desired resistance of the thermistor.

The specified voltage U [V] is related to the resistance of the thermistor R [Ohm] by the formula:

$$U = \frac{2.5 R}{10000} - 1.25$$

For example, to obtain a thermistor resistance of 10000 Ohm, a voltage of 1.25 V must be applied to the «TEC temperature set» pin. The 10 kOhm resistance corresponds to 25 ° C for the NTC thermistor 10k. A lower input voltage corresponds to a lower resistance of the thermistor (higher temperature) and vice versa.

When you translating the resistance of the thermistor to the temperature t [° C], it is necessary to consider the coefficient B25 / 100 [K], specified in the manufacturer's specifications:

$$t = \frac{1}{\frac{\ln \frac{R}{10000}}{B_{25/100}} + \frac{1}{298.15}} - 273.15$$

#### 14.7. Driver current monitor

The output current of the driver can be monitored by current monitor.

#### 14.8. TEC temperature monitor

The «TEC temperature monitor» pin is an analog output and allows you to track the temperature of the laser diode.

Proportions described in paragraph 12.6 are valid for this Pin.

#### 14.9. NTC Interlock

Thermistor connection. Allows you to measure the temperature of a laser or other devices. The measurement result is readable by the digital interface. Set upper and lower limits of the temperature at the outlet of which driver operation is blocked. When the temperature returns to the specified range, the driver operation resumes.



## 15. Current / Temperature setting variants

Parameters can be set in three ways: using potentiometer, analog control connector or digital commands. Signal sources for current and temperature can be set independently of each other.

Signal source	Digital state	Board jumper state
<b>Potentiometer</b>	External (default at power up)	INT
<b>Analog control connector</b>	External (default at power up)	EXT
<b>Digital</b>	Internal	INT or EXT

## 16. How to get started

Unpack the device. The new device is configured with the following values:

Parameter	Value
Peltier module current limit (set by digital)	2A
Temperature control (switch TEMP)	INT
TEC temperature set (potentiometer TEMP)	10kOhm (25°C)
Laser diode driver current set (potentiometer CURRENT)	0mA
Laser diode driver current control (switch CURRENT)	INT
Laser diode driver current protection threshold (potentiometer DRV OC)	2/5 of max current

### 16.1. Change the current limit on the Peltier module

If it is necessary, the level of current limit on the Peltier module can be changed before connecting the laser diode using digital control connection.

### 16.2. Change the current protection threshold of the driver

If it is necessary, the current protection threshold can be changed before connection of a laser diode. Make sure that the jumper DRIVER SHORT is installed. Current control switch CURRENT must be in the INT position to use the potentiometer CURRENT.

Connect the measuring instrument to the «*Driver Current Monitor*» pin.

If it is necessary to increase the limitation level, turn the potentiometer DRV OC clockwise for a few turns.

Turn on the driver. Set the current equal to the desired current protection threshold with the potentiometer CURRENT. Then slowly turn the potentiometer DRV OC counterclockwise until the protection is activated. Restart the driver to reset an error. Make sure that the protection is triggered at the correct current.

Set current to zero, turn off the driver.

## 17. Cooling

The board does not require active cooling. Aluminum mount is designed to remove heat from the laser diode.



### 18. Internal protections

The device provides several security features to ensure the safety of the laser module.

The jumper shunts the outputs of driver, to protect the laser diode from static discharges while installing.

Before installing the laser module on the board, make sure there is a jumper! Remove the jumper before turning on the driver.

Reverse diode protects the laser diode from reverse current and reverse voltage.

In case of an over-current or an over temperature condition, the control logic disables the driver and the output shorts with 2 mOhm shunt. Setting the current protection threshold is described in paragraph 13. The current protection threshold must be less than the laser module absolute maximum ratings.

The TEC current limit allows setting the maximum current safe for the Peltier module.

### 19. Software

We offer own software to control driver. If you need it, please contact us at info@maimanelectronics.com.

### 20. Digital control description

When the input voltage applied the driver is always in "analogue parameters set, external enable and allowing interlock" state. Any other state should be set any time after powering the driver if needed.

#### Default serial port settings:

Baud rate	Data bits	Stop bits	Parity	Flow control
115200	8	1	none	None

Data exchange between the driver and the PC is only initiated by the PC. **All commands are sent in plain text format. All commands in text-plain mode should be in ASCII.** All commands are sent with prefix. Number of command follows the prefix without any symbols. If there is the value after the command they separates with "space" symbol. The command ends with "carriage return" symbol.

The format of the command to set the value (P-type):

Number of byte	Value	Comment
1	P (50h)	Set prefix
2-5	Number of the parameter	Hex-number of the parameter. For example, 0100h
6	'space' symbol (20h)	
7-10	New value of the parameter	Hex-value of the parameter. For example, 0000h
11	'return carriage' symbol<CR> (0Dh)	End of the command



The device does not respond to P-type commands by default (see section "the protocol extension").

You can request the value of parameter by the J-type command. The device will return a value of requested parameter.

The format of the command to get the value (J-type):

Number of byte	Value	Comment
1	J (4Ah)	Request prefix
2-5	Number of the parameter	Hex-number of the parameter. For example, 0100h
6	'return carriage' symbol<CR> (0Dh)	End of the command

The format of the response:

Number of byte	Value	Comment
1	K (4Bh)	Response prefix
2-5	Number of the parameter	Hex-number of the requested parameter
6	'space' symbol (20h)	
7-10	Returned value of the parameter	Hex-value of the parameter
11	'return carriage' symbol<CR> (0Dh)	End of the command

If the device could not recognize a command, it returns an error message with error code.

The format and codes of errors

Error (returned command)	Reasons (one or few)
<b>E0000</b>	1) Internal buffer of device is overflowed. 2) Cannot find <CR> (0x0D) or \and <LF> (0x0A). 3) Format of command is invalid.
<b>E0001</b>	1) Unknown command (it does not P- or J-type command). 2) The device failed to correctly interpret a command.
<b>E0002</b>	The CRC of received command (see section "the protocol extension").
<b>K0000 0000</b>	Request or set the parameter that does not exist.

Available parameters and its description

Action		R/W	HEX-number of parameters
<b>Frequency (0.1 Hz)</b>	Value	R/W	0100
	Minimum	R	0101
	Maximum	R	0102



<b>Duration (0.1 ms)</b>	Value		R/W	0200
	Minimum		R	0201
	Maximum		R	0202
<b>Current (0.1 mA)</b>	Value		R/W	0300
	Minimum		R	0301
	Maximum		R/W	0302
	Maximum limit		R	0306
	Measured value		R	0307
<b>Current set calibration (0.01%)<sup>2</sup></b>	Value		R/W	030E
<b>Voltage (0.1 V)</b>	Measured value		R	0407
<b>State of the driver (bit mask)</b>	Start (Enable)	0008h	<b>W</b>	0700
	Stop (Disable)	0010h		
<b>State of the driver (bit mask)</b>	Internal current set	0020h	<b>W</b>	0700
	External current set	0040h		
	External Enable	0200h		
	Internal Enable	0400h		
	Allow Interlock <sup>3</sup>	1000h		
	Deny Interlock <sup>3</sup>	2000h		
	Deny ext. NTC Interlock <sup>3</sup>	4000h		
	Allow ext. NTC Interlock <sup>3</sup>	8000h		
<b>State of the driver (bit mask)</b>	0 bit	1 – Device is powered on (always = 1)	<b>R</b>	0700
	1 <sup>st</sup> bit	0 – Stopped; 1 – Started		
	2 <sup>nd</sup> bit	Current set: 0 – External; 1 – Internal		
	4 <sup>th</sup> bit	Enable: 0 – External; 1 – Internal		
	6 <sup>th</sup> bit	External NTC Interlock: 0 – Allowed; 1 – Denied		
	7 <sup>th</sup> bit	Interlock: 0 – Allowed; 1 – Denied		
<b>Serial number</b>	Return the hex-value of the serial number		R	0701
<b>Lock status (bit mask)<sup>4</sup></b>	1 <sup>st</sup> bit	Interlock	R	0800
	3 <sup>rd</sup> bit	LD over current		

<sup>2</sup> Default – 100.00% (2710h), calibration range is from 95.00% (251Ch) to 105.00% (2904h).

<sup>3</sup> Common for driver and TEC.

<sup>4</sup> If temperature of the device reaches the over temperature warning threshold the overheat flag will be set. If the device is in over temperature protection state, then it will be set overheat and over current flags together.



	4 <sup>th</sup> bit	LD overheat		
	5 <sup>th</sup> bit	External NTC Interlock		
	6 <sup>th</sup> bit	TEC error		
	7 <sup>th</sup> bit	TEC self-heat		
<b>External NTC sensor temperature (0.1°C)</b>	Lower limit		R/W	0A05
	Upper limit		R/W	0A06
	Measured value		R	0AE4
	B <sub>25/100</sub> (1 = 1 K)		R/W	0B0E
<b>TEC temperature (0.01°C)</b>	Value		R/W	0A10
	Maximum		R/W	0A11
	Minimum		R/W	0A12
	Maximum limit		R	0A13
	Minimum limit		R	0A14
	Measured value		R	0A15
<b>TEC current (0.1 A)</b>	Measured value		R	0A16
	Limit		R/W	0A17
<b>TEC voltage (0.1 V)</b>	Measured value		R	0A18
<b>State of the TEC (bit mask)</b>	Start (Enable)	0008h	<b>W</b>	0A1A
	Stop (Disable)	0010h		
	Internal temperature set	0020h		
	External temperature set	0040h		
	External Enable	0200h		
	Internal Enable	0400h		
	1 <sup>st</sup> bit	0 – Stopped; 1 – Started	<b>R</b>	0A1A
	2 <sup>nd</sup> bit	Temperature set: 0 – External; 1 – Internal		
	4 <sup>th</sup> bit	Enable: 0 – External; 1 – Internal		
<b>Current set calibration (0.01%)<sup>5</sup></b>	Value		R/W	0A1E
<b>Internal LD NTC sensor</b>	B <sub>25/100</sub> (1 = 1 K)		R/W	0A1F

The maximum duration depends on the set value of the frequency. When you change frequency, a new value of the maximum duration is compute automatically. The duration of pulse cannot be less than 2 ms and more than period of frequency minus 2 ms. For low frequencies the duration cannot be more than 5000 ms.

<sup>5</sup> Default – 100.00% (2710h), calibration range is from 95.00% (251Ch) to 105.00% (2904h).





Set the zero frequency to switch the device into CW mode or set not zero frequency value to switch the device into QCW (long pulses) mode. If you try to set a value more or less than limits, then the value will be rounded to limit. Any attempts to set a new state of the device, except “start”, forcibly switch the device to the state “stop”. Some states of the device are mutually exclusive, for example, if you set “Ext. Enable”, then you will not be able to set the state “start”. If you send “start” and “stop” commands to each other, the device will save all parameters in the internal memory. The saving process lasts about 300 ms. In this time the device does not respond to any actions. The device is able to save the next parameters in the internal memory:

- Frequency with limits;
- Duration with limits;
- Current with limits and calibration;
- Temperature limits and B<sub>25/100</sub>;
- Settings of the RS protocol extension (see section «the protocol extension»).

### 21. Digital control description (extended)

**WARNING!** *Extended protocol recommend for advanced users only. In addition, it might be use for integration of the device with other devices.*

Use the parameter number 0704h for configure the extended protocol. In extended protocol, you can enable and disable the next options: checksum (CRC 8-bit CCITT), return a new value of parameter after P-type commands, change baud-rate, change protocol-mode (text-plain or binary).

The description of the protocol extension command

Action		R\W	HEX-number of parameters
<b>Information about the extended protocol</b>	0 bit	1 – the device supports this option	R 0704
	1st bit	Checksum (1 – on, 0 – off)	
	2nd bit	Return a new value for P-type commands (1 – on, 0 – off)	
	3-5 bits	Baud – rate 0 – 2400 1 – 9600 2 – 10417 3 – 19200 4 – 57600 5 – 115200 (default)	
	6th bit	Data exchange mode (1 – binary, 0 –text-plain)	



<b>Configuring of the extended protocol</b>	On checksum (CS)	0002h <sup>1</sup>	<b>W</b>	0704
	Off checksum	0004h <sup>1</sup>		
	Return a new value for P-type commands	0008h <sup>1</sup>		
	Do not return answer for P-type commands	0010h <sup>6</sup>		
	Set new baud-rate(baud) <sup>7</sup>	0100h – 2400 0120h – 9600 0140h – 10 417 0180h – 57 600 01A0h – 115200		
	Text-plain mode on <sup>8</sup>	0200h		
	Binary mode on	0400h		

**Text-plain mode**

All commands in text-plain mode should be in ASCII.

**WARNING!** *If you enable the checksum it will change format of commands. After <CR> symbol you will be write 2 bytes of checksum and last byte will be <LF> (0Ah – “new line” symbol). Checksum is computed for all bytes of command before checksum bytes (including<CR> symbol).*

All answers of the device will also contain a checksum, including K-type and E-type answers. Checksum is computed by CRC-CCITT-8 algorithm. This is the main difference between the format of commands for the extended protocol and standard protocol.

The format of commands for enabled checksum

<b>Number of byte</b>	<b>Value</b>	<b>Comment</b>
<b>1</b>	P,J,K,E	Type of command
<b>2-5</b>	Number of parameter	Hex-number of value
<b>6</b>	‘space’ symbol (20h)	<i>(does not use for J and E-type commands)</i>
<b>7-10</b>	New value of the parameter	Hex-value of parameter <i>(does not use for J and E-type commands)</i>
<b>11</b>	‘return carriage’ symbol<CR> (0Dh)	End of value
<b>12-13</b>	Checksum	CRC checksum of the first 11 bytes <i>(for J and E-type commands checksum is computed for the</i>

<sup>6</sup> In binary mode the specified commands are ignored by the device.

<sup>7</sup> Here are binary numbers.

<sup>8</sup> For more information, see section “binary mode”.



		<i>first 6 bytes), including &lt;CR&gt; symbol.</i>
<b>14</b>	'new line' symbol<LF> (0Ah)	End of command

### Possible problems

1. The device waiting for symbol <LF>. If <LF> symbol does not received and buffer is overflowed, then all symbols after overload will be processed as a new command. The device returns an error. In this case, it is recommended to send the <LF> symbol. The device will generate an error and clear the buffer for the next command.
2. All symbols after the <LF> symbol will be processed as a new command.

### Binary mode

The binary mode has a significant difference. In this mode, data are exchanged in binary form. Length of any type of command is 8 bytes! In this mode, next options are always enable and you cannot disable it: return a new value of parameter for P-type commands and checksum. The format of binary mode commands is represented in table 8.

The format of binary mode commands

<b>Number of byte</b>	<b>Value</b>	<b>Comment</b>
<b>1</b>	Type of command	50h (P - ascii) – Set a new value of parameter 4Ah (J - ascii) – Get a value of parameter 4Bh (K - ascii) – Answer of the device 45h (E - ascii) – Error
<b>2-3</b>	Number of parameter	Hex-number of parameter
<b>4-5</b>	Value of parameter	Hex-value of parameter. This value is <b>STRICTLY REQUIRED</b> in the binary mode. If this value does not make sense, it will be returned as 0000 (K or E-type commands) or you should set it field to any value (for P or J-type commands).
<b>6</b>	'return carriage' symbol <CR> (0Dh)	End of value
<b>7</b>	Checksum	CRC checksum of the first 11 bytes ( <i>for J and E-type commands checksum is computed for the first 6 bytes), including &lt;CR&gt; symbol.</i>
<b>8</b>	'new line' symbol <LF> (0Ah)	End of command



## 22. Mechanical dimensions

### 22.1. SF8xxx-10 model for soldering 10-pin Butterfly

All dimensions are in millimeters.

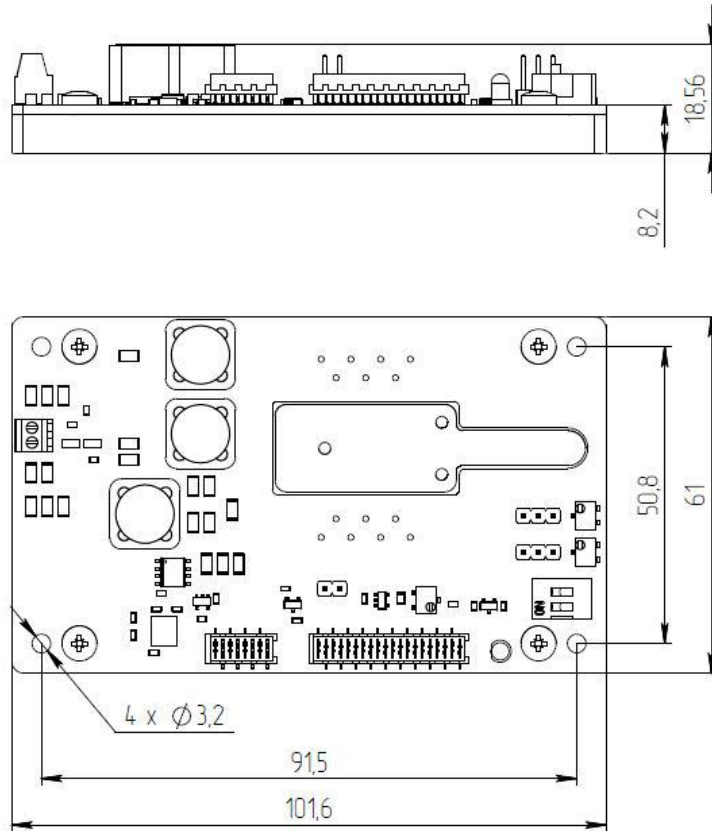



### 22.2. SF8xxx-14 model for soldering 14-pin Butterfly

All dimensions are in millimeters.

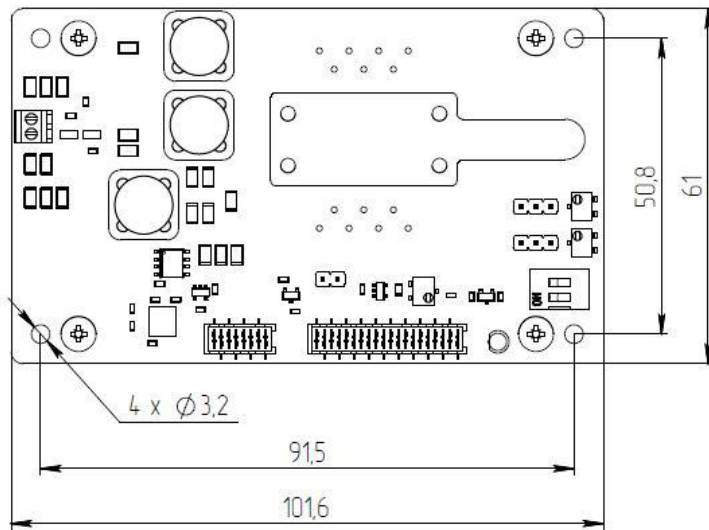
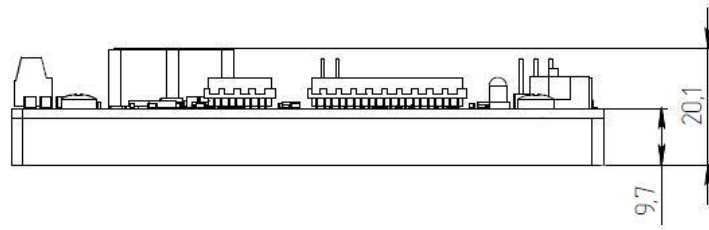



### 22.3. SF8xxx-ZIF10 model with Azimuth connectors for 10-pin Butterfly

All dimensions are in millimeters.

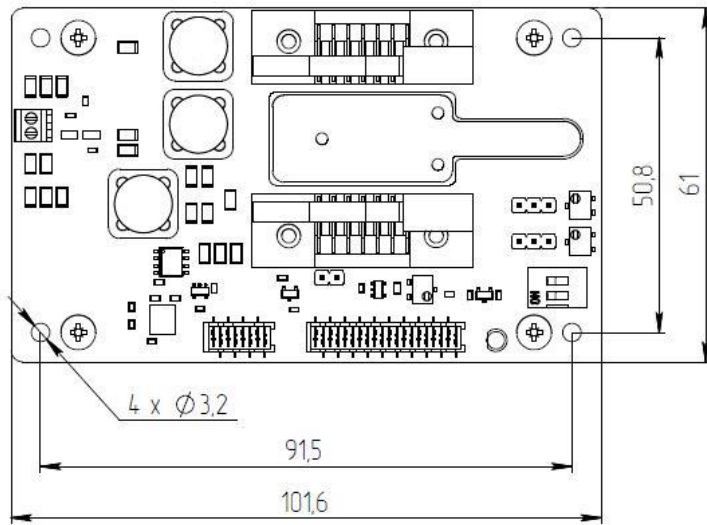
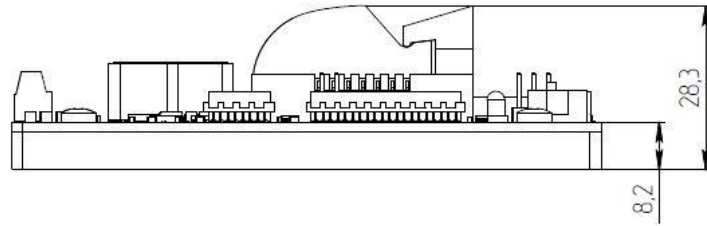



### 22.4. SF8xxx-ZIF14 model with Azimuth connectors for 14-pin Butterfly

All dimensions are in millimeters.

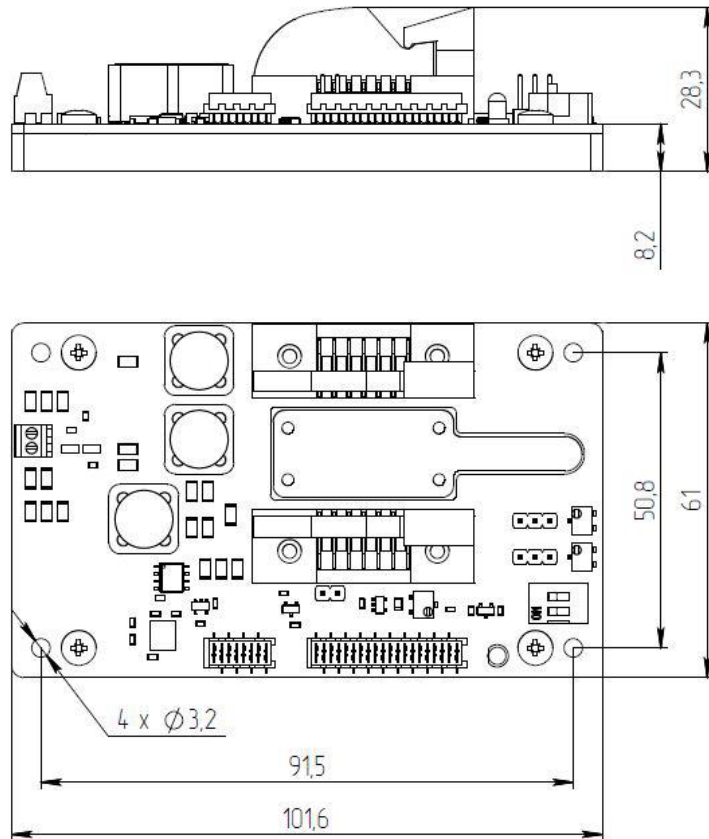



OPTOGAMA, UAB  
Mokslininku str. 2A,  
LT-08412, Vilnius, Lithuania  
+37052194884  
[sales@optogama.com](mailto:sales@optogama.com)  
[www.optogama.com](http://www.optogama.com)  
[www.4Lasers.com](http://www.4Lasers.com)

